

Predicted and measured EMI shielding effectiveness of a metallic mesh coating on a sapphire window over a broad frequency range

Keith T. Jacoby*^a, Matthew W. Pieratt^a, Jennifer I. Halman^b, Keith A. Ramsey^b

^aExotic Electro-Optics (EEO), 36570 Briggs Rd Murrieta, CA 92563;

^bBattelle Memorial Institute (BMI), 505 King Avenue Columbus, OH 43201

ABSTRACT

Metallic mesh thin film coatings have been used for many years to provide electromagnetic interference (EMI) shielding on infrared windows and domes. The level of EMI shielding effectiveness (SE) of metallic mesh coatings when used in a high frequency application is understood and characterized. Conversely, the level of SE of these metallic mesh coatings when used in a low frequency application has been called into question. In a recent study, we applied an appropriately designed metallic mesh coating to a sapphire window, mounted that window in a fixture, and tested the SE of the window assembly over a frequency range that envelopes the various military platforms covered in MIL-STD-461 (10 kHz to 18 GHz) for a radiated emissions test. The test plan was devised in such a way as to independently assess the individual contributions of the aperture, the mounting, and the metallic mesh coating to the total shielding. The results of our testing will be described in this paper. Additionally, the test results will be compared to the predicted SE for both the aperture and the metallic mesh coated window in order to validate the predictive model. Finally, an assessment of the appropriateness of the use of metallic mesh coatings for EMI shielding in a low and / or broad range frequency application will be made.

Keywords: EMI, shielding effectiveness, metallic mesh coatings, grids, sapphire

1. INTRODUCTION

Proper electromagnetic shielding is an important factor in providing protection for sensitive equipment in both military and civilian applications, such as sensors. Undesirable radiation can cause electromagnetic interference (EMI), which can take the form of damage or other unacceptable responses in operation. Often, testing for various military applications conforms to MIL-STD-461, which specifies electromagnetic compliance (EMC) for conducted emissions, conducted susceptibility, radiated emissions and radiated susceptibility. Susceptible components to EMI are often located behind optics. System designers establish functional exposure levels for internal circuitry to outside or controlled radiation, resulting in the flowing down of the proper requirements to the manufacturer of the optic or optical assembly. Thus, shielding against EMI is used to reduce radiated emissions from a system or reduce radiated susceptibility of a system and the term often used for such a specification is shielding effectiveness (SE). Fundamentally, SE is the ratio of the incident wave to the transmission wave for either the electric field (most common) or magnetic field, whether in the near-field or far-field.

This effort attempts to move closer to a definitive answer to the following questions:

1. Are the appropriately designed metallic mesh coatings a viable solution to a broadband EMI shielding problem?
2. Can metallic mesh coatings provide shielding at the lower frequencies range?
3. Can a test method be developed that quantifies the contribution of the metallic mesh coating and substrate to the overall shielding effectiveness of a test assembly?
4. Does the existing model accurately predict the SE of a metallic mesh coated window from 10 KHz to 18GHz?

This paper describes the results of modeling and experimentation specifically designed to address those questions for a metallic mesh coating on a sapphire window. Battelle Memorial Institute deposited the metallic mesh coating and provided the theoretical model. Exotic Electro-Optics provided the fabricated sapphire window and conducted the testing and analysis.

*kjacob@exotic-eo.com; phone 1 951 926-7663; fax 1 951 926-1984; www.exotic-eo.com

Keith T. Jacoby, EEO; Matthew W. Pieratt, EEO; Jennifer I. Halman; Keith A. Ramsey, "Predicted and measured EMI shielding effectiveness of a metallic mesh coating on a sapphire window over a broad frequency range," Window and Dome Technologies and Materials XI, Randal W. Tustison, Volume 7302, Page 7302OX, 2009

Copyright 2009 Society of Photo-Optical Instrumentation Engineers. One print or electronic copy may be made for personal use only. Systematic reproduction and distribution, duplication of any material in this paper for a fee or commercial purposes, or modification of the content of the paper are prohibited.

<http://dx.doi.org/10.1117/12.818200>

2. GRID COATING DESIGN AND MODEL PREDICTION

Metallic mesh coatings are routinely deposited on infrared windows to provide electromagnetic shielding to the electronics and sensors operating behind the windows. An example of a metallic mesh coating using a square mesh pattern is shown in Figure 1.

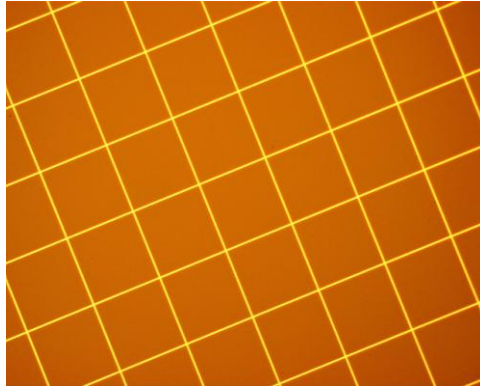

Figure 1: Typical Square Mesh Coating, 5 μm wide lines, 50 μm center-to-center line spacing.

The advantage of a mesh coating over a continuous conductive coating is that the mesh will provide high visible and infrared transmittance while also providing high microwave and RF shielding. Continuous conductive coatings such as indium tin oxide, $\text{In}_{2-x}\text{Sn}_x\text{O}_3$, or ITO, can be used to provide shielding for visible window applications, but for many applications mesh coatings can provide higher optical/IR transmittance, lower effective sheet resistance, and higher shielding. ITO and most continuous conductive coatings do not transmit well in the infrared.

The visible and infrared transmittance of a mesh coating is a function of the geometry of the mesh. The total visible or infrared transmittance of the mesh is equal to the percent open area of the mesh. Due to diffraction by the grid at visible and infrared wavelengths, the transmittance of the mesh through the zero-order or main diffraction lobe is approximately equal to the square of the percent open area.

Several factors control the SE of a metallic mesh coating. Thicker metal will decrease the effective sheet resistance of the mesh, increasing the shielding, especially at the lower frequencies. Increasing the line widths of a mesh and reducing the spacing between the lines will also increase the shielding, but these changes will also reduce the visible and infrared transmittance.

Metallic mesh coatings do have the disadvantage of diffraction versus continuous coatings. Although diffraction cannot be eliminated when using a mesh, the effects can be reduced by randomizing the pattern and/or selecting a non-uniform pattern.

Shielding Effectiveness Predictions

SE is the attenuation of an incident electromagnetic plane wave field as it is transmitted through the mesh-coated window,

$$SE = 20 \log_{10} \left| \frac{E_i}{E_t} \right| \quad (1)$$

Keith T. Jacoby, EEO; Matthew W. Pieratt, EEO; Jennifer I. Halman; Keith A. Ramsey, "Predicted and measured EMI shielding effectiveness of a metallic mesh coating on a sapphire window over a broad frequency range," Window and Dome Technologies and Materials XI, Randal W. Tustison, Volume 7302, Page 7302OX, 2009

Copyright 2009 Society of Photo-Optical Instrumentation Engineers. One print or electronic copy may be made for personal use only. Systematic reproduction and distribution, duplication of any material in this paper for a fee or commercial purposes, or modification of the content of the paper are prohibited.

<http://dx.doi.org/10.1117/12.818200>

where E_i and E_t are the incident and transmitted electric fields, respectively. As long as the thickness of the mesh coating is much less than a skin depth, δ , where the skin depth is defined as follows:

$$\delta = \sqrt{\frac{2}{\omega\mu\sigma}}, \quad (2)$$

$$\omega = 2\pi f,$$

$$\mu = \text{permeability},$$

$$\sigma = \text{conductivity, and}$$

$$f = \text{frequency},$$

the SE is almost entirely due to reflection of the incident plane wave at the air to mesh interface. Mesh coatings are usually less than 1 or 2 μm thick and the skin depth of gold at 18 GHz is 0.56 μm , so the mesh coatings are generally much less than a skin depth for microwave and lower frequencies.

The transmission coefficient of an infinite metallic sheet of thickness t due to a normally incident plane electromagnetic wave is given by transmission line theory.¹ For thin continuous conductive films the transmission coefficient and the SE is independent of frequency and can be characterized by the sheet resistance of the coating, R_c ,

$$R_c = \frac{1}{\sigma t} \quad (3)$$

As long as the thickness t is less than the skin depth and the conductive coating has low intrinsic impedance compared to free space, ignoring the effects of the substrate, the SE is²

$$SE = 20 \log_{10} \left[\frac{1}{1 + \frac{\eta_0}{2R_c}} \right] \quad (4)$$

where

$$\eta_0 = \sqrt{\frac{\mu_0}{\epsilon_0}}$$

The SE of a metallic mesh coating depends on frequency as well as the sheet resistance of the metal comprising the mesh, the mesh geometry, the permittivity of the window material, and the thickness of the window.

At low frequencies, as long as the incident fields are plane waves, a metallic mesh coating performs as a continuous conductive coating. The SE is given by equation 4, using an effective sheet resistance, R_{eff} , in place of R_c . The effective sheet resistance of a square mesh coating is

$$R_{eff} = \frac{g}{l} R_c, \quad (5)$$

Keith T. Jacoby, EEO; Matthew W. Pieratt, EEO; Jennifer I. Halman; Keith A. Ramsey, "Predicted and measured EMI shielding effectiveness of a metallic mesh coating on a sapphire window over a broad frequency range," Window and Dome Technologies and Materials XI, Randal W. Tustison, Volume 7302, Page 7302OX, 2009

Copyright 2009 Society of Photo-Optical Instrumentation Engineers. One print or electronic copy may be made for personal use only. Systematic reproduction and distribution, duplication of any material in this paper for a fee or commercial purposes, or modification of the content of the paper are prohibited.

where g is the line spacing and l is the line width. As the frequency increases, the frequency dependence of the mesh must be taken into account. Battelle has modeled the plane wave transmittance of a mesh coated window as a function of frequency. The model is based on the transmission coefficient analysis for arbitrary layered media by Ruck³ and an empirically developed frequency-dependent model for the impedance of the finitely conductive metallic mesh coating. Based on a Battelle's model of the plane wave transmittance of multilayer structures, the SE of a metallic mesh coating with 5 micron-wide lines and 50 micron line spacing as a function of frequency is shown in Figure 2. Taking into consideration the continuous metal sheet resistance, the effective sheet resistance of this mesh coating is 0.2 ohms/sq.

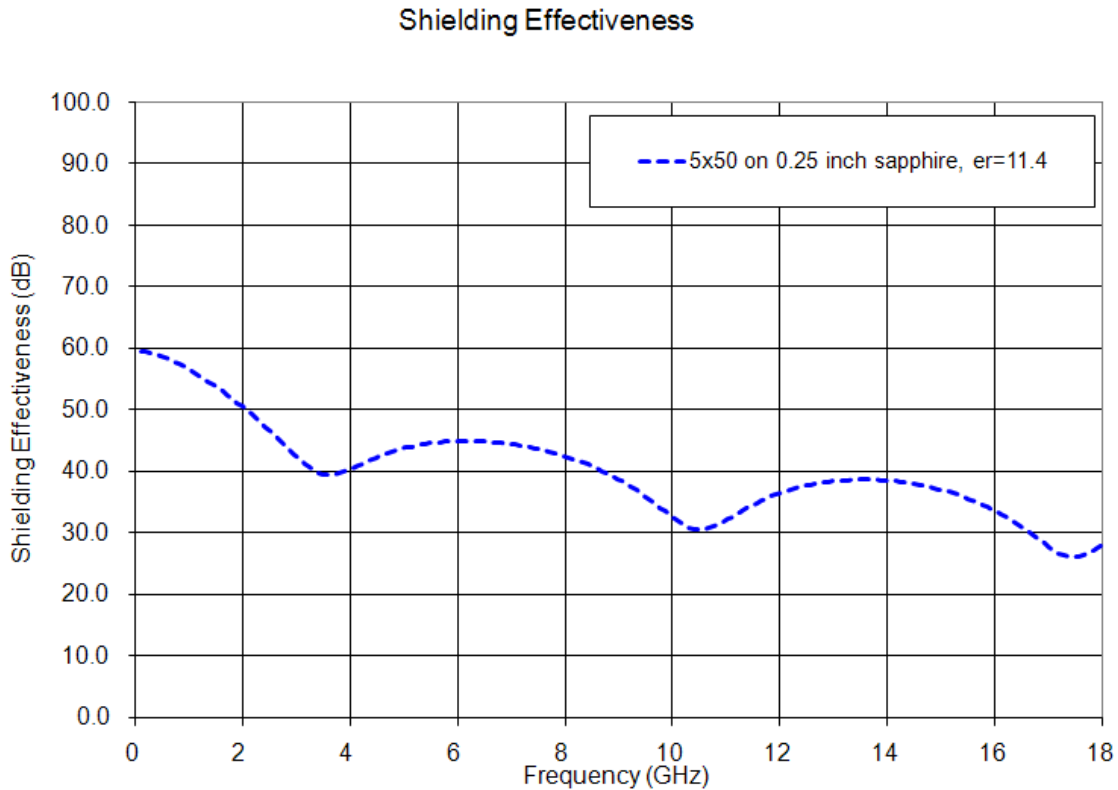

Figure 2: Predicted shielding effectiveness of a 5x50 square mesh coating on 0.25-inch thick sapphire

The SE of a continuous coating with a sheet resistance of 0.2 ohms/sq is approximately 60 dB at DC. At low frequencies, where the apertures in the mesh are much smaller than a wavelength, the mesh will perform exactly like a thin continuous conductive film of the same sheet resistance.

At higher frequencies, where the wavelengths are nearer to the dimensions of the apertures in the mesh, the mesh begins to leak and the SE is reduced as frequency increases.

3. PANEL AND TEST FIXTURING CONFIGURATION

A patterned conductive mesh coating and buss bars were applied by Battelle to one side of a 10 ½ x 8 ½ x ¼ inch thick polished sapphire window fabricated by Exotic Electro-Optics. The mesh coating was patterned in the central 9 ¾ x 7 ¾ inch area and terminated with a solid buss bar applied around the entire perimeter of the coated side of the panel. The mesh coating and the buss bar have the same metal stack composition. The test frame and retainer are made out of 6061-T6 aluminum. The retainer is held to the back of the frame by 16x 8-32 stainless steel socket head cap screws. The recess in the frame was sized to hold a 0.125 inch thick conductive silicone gasket (MIL-G-E352E), the mesh coated sapphire window, and a 0.125 inch thick silicone gasket. The compression in the conductive gasket developed when the retainer was torqued down 15-25%. The frame is mounted to the test chamber wall using 12x ¼-20 steel socket head cap

Keith T. Jacoby, EEO; Matthew W. Pieratt, EEO; Jennifer I. Halman; Keith A. Ramsey, "Predicted and measured EMI shielding effectiveness of a metallic mesh coating on a sapphire window over a broad frequency range," Window and Dome Technologies and Materials XI, Randal W. Tustison, Volume 7302, Page 7302OX, 2009

Copyright 2009 Society of Photo-Optical Instrumentation Engineers. One print or electronic copy may be made for personal use only. Systematic reproduction and distribution, duplication of any material in this paper for a fee or commercial purposes, or modification of the content of the paper are prohibited.

screws. The assembly is built up in the following sequence: frame – conductive gasket – conductive side of window – silicone gasket – retainer. Figures 3 and 4 shows the test assembly.

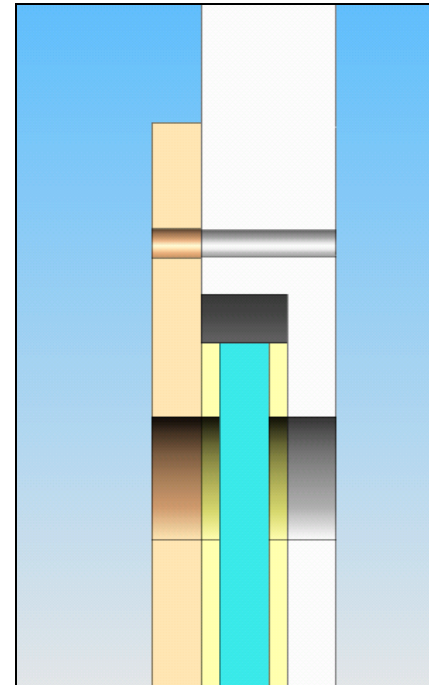
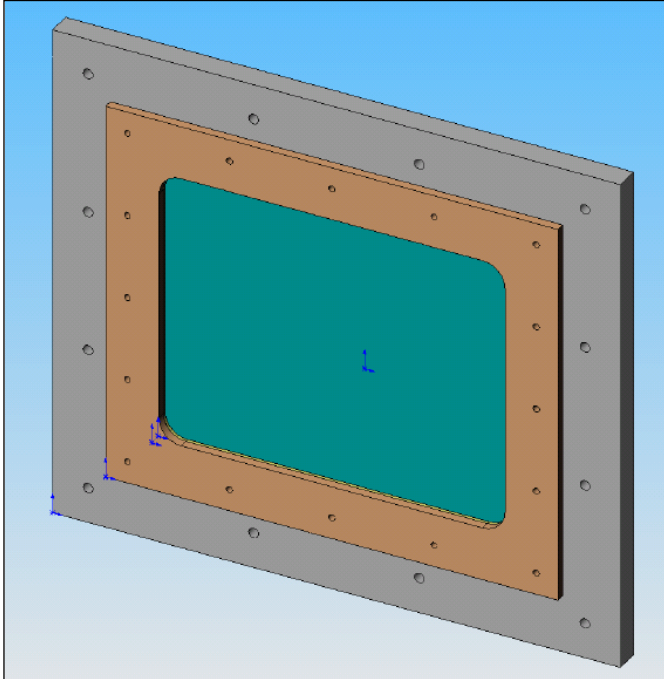

Figure 3: Window and Test Fixture Configuration



Figure 4: The window is put in place with the conductive gasket making contact with the buss bar and the fixture. A non-conducting gasket and retainer are placed on the opposite side to sandwich the window in place.

Keith T. Jacoby, EEO; Matthew W. Pieratt, EEO; Jennifer I. Halman; Keith A. Ramsey, "Predicted and measured EMI shielding effectiveness of a metallic mesh coating on a sapphire window over a broad frequency range," Window and Dome Technologies and Materials XI, Randal W. Tustison, Volume 7302, Page 7302OX, 2009

Copyright 2009 Society of Photo-Optical Instrumentation Engineers. One print or electronic copy may be made for personal use only. Systematic reproduction and distribution, duplication of any material in this paper for a fee or commercial purposes, or modification of the content of the paper are prohibited.

<http://dx.doi.org/10.1117/12.818200>

4. TEST PROCEDURE

Approach

The goal of the testing is to determine the contribution of the window to the assembly's total SE. A series of test runs were performed that would allow for the extraction of the window's SE. The following is a list of the measurements performed for each of the four antenna set-ups:

- Open aperture (nothing in pass through): Establishes baseline for comparison to all measurements.
- Solid Aluminum Plate: Measures leakage around frame mounting and permeability of aluminum.
- Frame: Establishes baseline for window SE contribution.
- Frame + Solid Al Plate: Measures leakage around conductive gasket.
- Frame + Window: Measure of the total SE of the test assembly.

Experimental setup

Testing was performed at Stork-Garwood Laboratories (Pico Rivera, California). The setup at Garwood consists of two chambers lined with 1mm thick galvanized steel on both sides of 18mm thick particle board, and an opening between the two rooms for a unit under test (UUT). The source antenna was placed in the larger room with dimensions of 3.65m x 5.5 m x 3.65 m and the receiving antenna was placed in the smaller room with dimensions of 3.05 m x 3.65 m x 3.65 m (see Figure 5). The open aperture is 0.5 m wide and 0.35 m high (20 inches x 14 inches), and located 1.5m up from the conductive floor. The test fixture's aperture is about 0.25 m wide and 0.20 m high (10 inches x 8 inches).

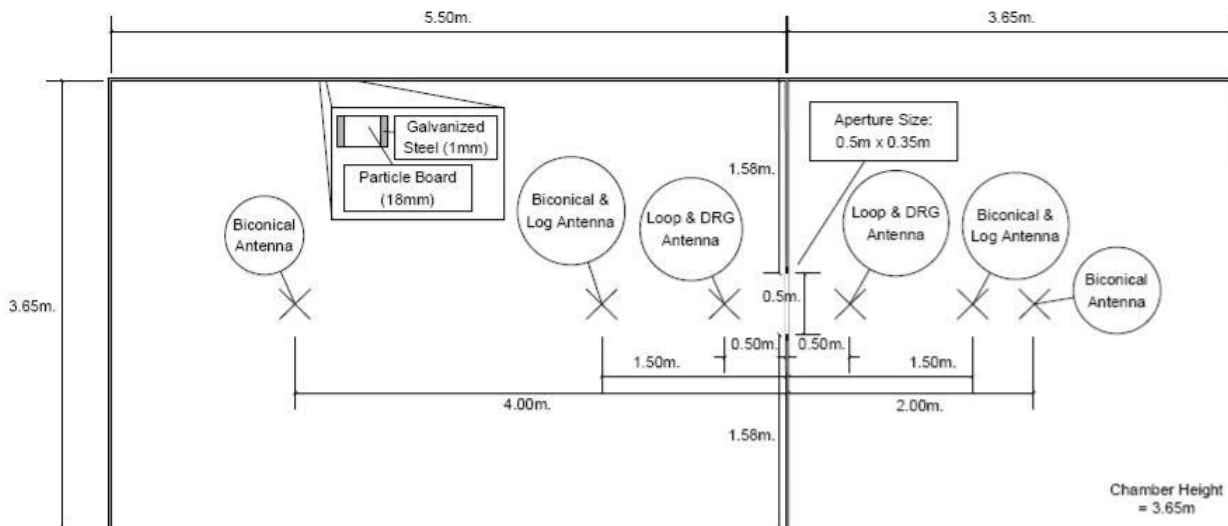

Figure 5: Experimental setup: includes dimensions of the chamber, antenna spacing, and material composition of chamber.

Different antennas were used for specific frequency ranges and are listed in Table 1. The biconical antenna was tested at 3 m separation and, though not listed in the table, tested again at 6 m in an attempt to create a “more plane-wave” EM field.

Table 1: Frequency range for each antenna configuration. The wavelength range is also listed for reference.

Frequency Range	Antenna type	Total separation	Wavelength
10kHz to 30MHz	12 inch loop	1 m	30km to 10m
30MHz to 200MHz	Biconical	3 m	10m to 1.5m
200MHz to 1GHz	Log periodic	3 m	1.5m to 0.3m

Keith T. Jacoby, EEO; Matthew W. Pieratt, EEO; Jennifer I. Halman; Keith A. Ramsey, “Predicted and measured EMI shielding effectiveness of a metallic mesh coating on a sapphire window over a broad frequency range,” Window and Dome Technologies and Materials XI, Randal W. Tustison, Volume 7302, Page 7302OX, 2009

Copyright 2009 Society of Photo-Optical Instrumentation Engineers. One print or electronic copy may be made for personal use only. Systematic reproduction and distribution, duplication of any material in this paper for a fee or commercial purposes, or modification of the content of the paper are prohibited.

1GHz to 18GHz	Horn (double ridge guide)	1 m	0.3m to 1.7cm
---------------	---------------------------	-----	---------------

Different setups were used in hopes of achieving a more accurate SE result. The following pictures show the various setups and antennas being used. The terms chosen and pictures should aid in understanding the results following.



Figure 6: Loop antenna setup with the receive antenna shown.

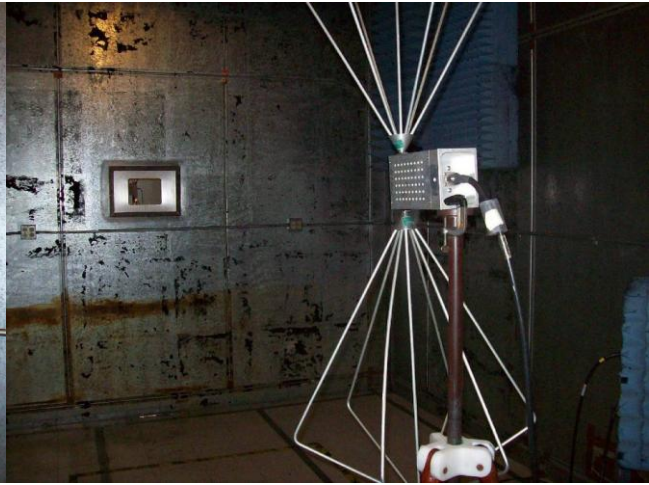

Figure 7: Biconical antenna tested at both 3m and 6m separation. The one shown above is the latter, 4m from the wall on the transmitting side. Note the sparse cones in the figure.

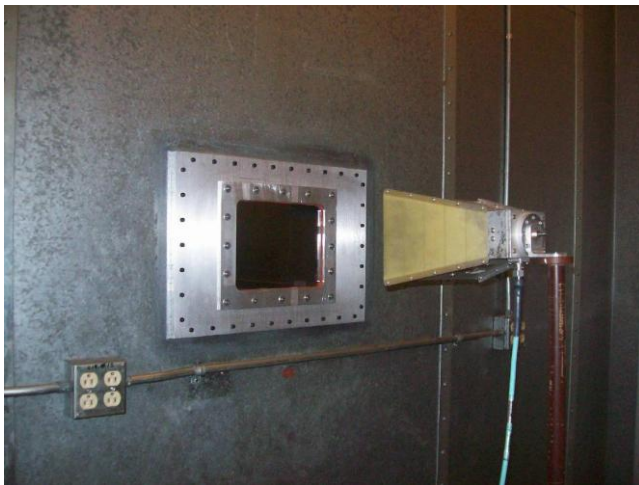

Figure 8: Log antenna on receiving side.



Figure 9: Horn antenna on receiving side.

Keith T. Jacoby, EEO; Matthew W. Pieratt, EEO; Jennifer I. Halman; Keith A. Ramsey, "Predicted and measured EMI shielding effectiveness of a metallic mesh coating on a sapphire window over a broad frequency range," Window and Dome Technologies and Materials XI, Randal W. Tustison, Volume 7302, Page 7302OX, 2009

Copyright 2009 Society of Photo-Optical Instrumentation Engineers. One print or electronic copy may be made for personal use only. Systematic reproduction and distribution, duplication of any material in this paper for a fee or commercial purposes, or modification of the content of the paper are prohibited.

<http://dx.doi.org/10.1117/12.818200>

5. COMPARISON OF MODEL PREDICTED PERFORMANCE AND TEST RESULTS

The results of the SE measurements compared to the model predictions are shown in Figure 10 and Figure 11. The trend of the measured data agrees with the model from about 1 to 18 GHz, although the measured SE is higher than expected.

The measured SE continues to increase as the frequency decreases as expected until the frequency reaches about 300 MHz. The measured SE drops below the expected value below about 300 MHz. This may be due to low signal-to-noise ratios at low frequency or because at low frequencies the measurements are in the near field and the incident radiation is not in the form of plane waves. At 1 GHz, the wavelength is 0.3 meters. At 10 MHz, the wavelength is 30 meters. The size of the aperture is 0.267 m by 0.216 m. The energy that gets through the small aperture at low frequencies is low even when there is no window present. Most of the energy is blocked by the small aperture.

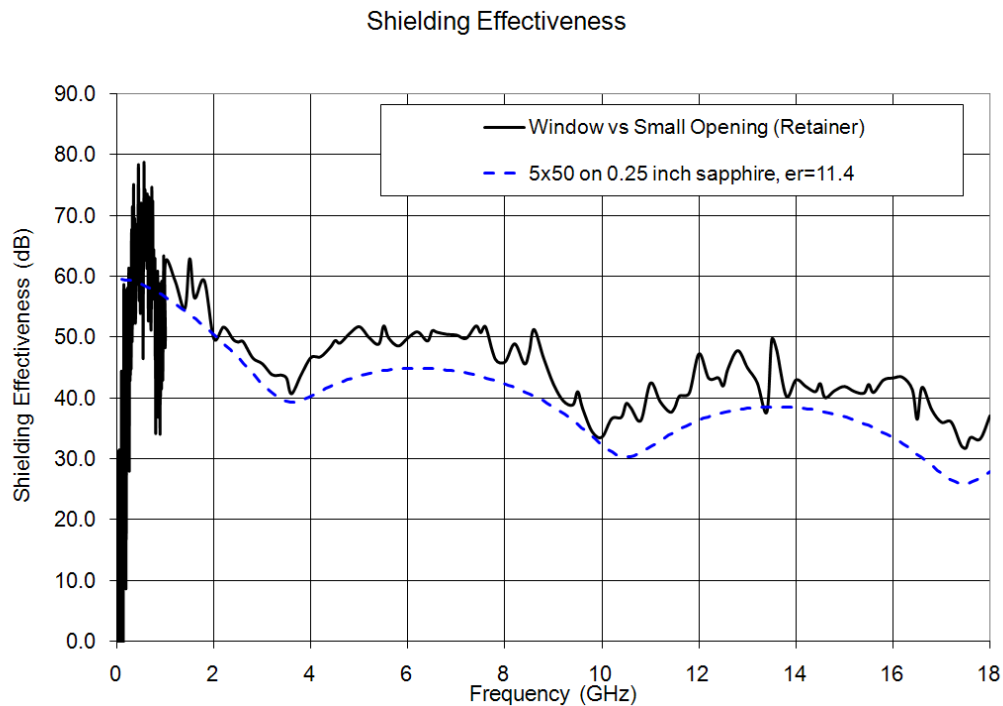

Figure 10: Predicted and measured shielding effectiveness of a 5x50 square mesh coating on 0.25-inch thick sapphire, 1 to 18 GHz

Keith T. Jacoby, EEO; Matthew W. Pieratt, EEO; Jennifer I. Halman; Keith A. Ramsey, "Predicted and measured EMI shielding effectiveness of a metallic mesh coating on a sapphire window over a broad frequency range," Window and Dome Technologies and Materials XI, Randal W. Tustison, Volume 7302, Page 7302OX, 2009

Copyright 2009 Society of Photo-Optical Instrumentation Engineers. One print or electronic copy may be made for personal use only. Systematic reproduction and distribution, duplication of any material in this paper for a fee or commercial purposes, or modification of the content of the paper are prohibited.

<http://dx.doi.org/10.1117/12.818200>

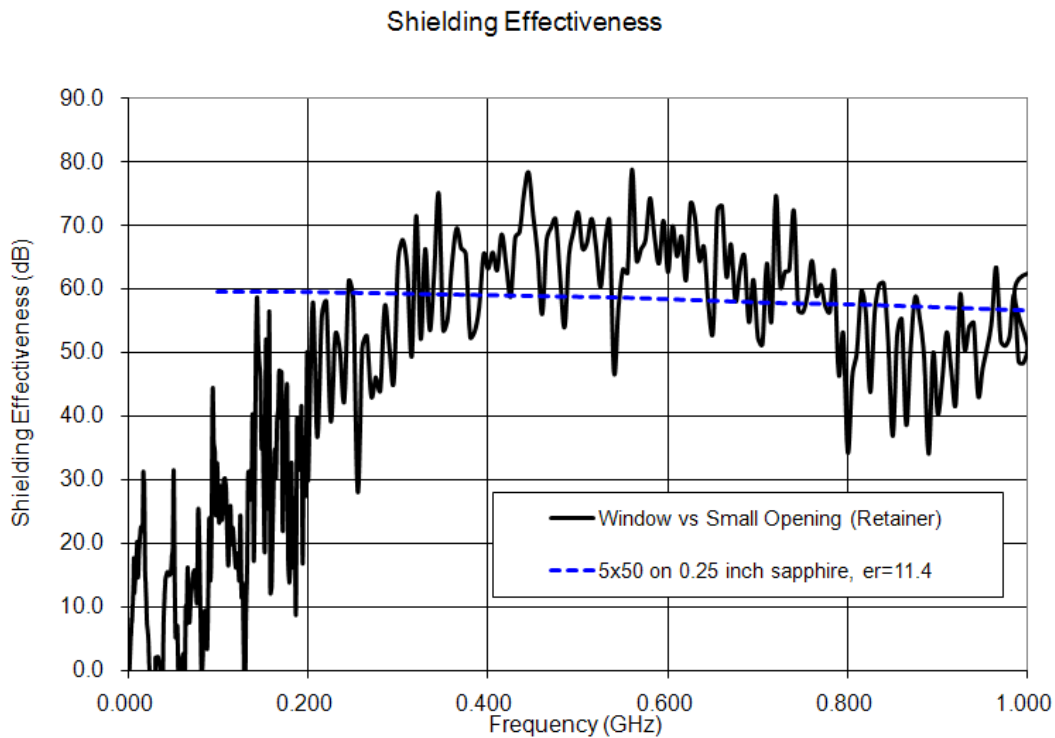

Figure 11: Predicted and measured shielding effectiveness of a 5x50 square mesh coating on 0.25-inch thick sapphire, 0 to 1 GHz

6. OTHER CONSIDERATIONS

The SE for the window was attained by exposing the aperture of the fixture, also known as the “small opening”, which included the retainer and gasket, and then exposing the same configuration with the window in place. For the lowest frequency band, 10 kHz to 30 MHz, a loop antenna was used, which has a large magnetic-field component. Aluminum is a poor magnetic shield for the lower frequencies. This became evident from 10 kHz to 100 kHz, where there was almost zero dB shielding, for both the window and the aluminum plate measurements. With limitations in shielding against magnetic near-field, the data for the loop antenna is suspect.

For the next frequency range, 30 MHz to 200 MHz, a biconical antenna was used. Again, the measured SE decreased as the frequency decreased. To make the measurements more “plane-wave” in this region the antenna separation was increased from 3 m to 6 m, but no clear difference was detected.

The log periodic antenna was used in the frequency range from 200 MHz to 1 GHz. This data does follow the trend of the biconical data and is much closer to the predicted SE, though the periodic nature is not fully understood. The double ridged horn antenna was used for frequencies greater than 1 GHz. The dips in the data are a function of the thickness of the material, the frequency and the dielectric constant. The horn antenna was oriented in the vertical direction, as were the other antennas (excluding the loop antenna), which passes through the c-axis of the sapphire window. The dielectric constant for this orientation is about 11.4.

A concern arises that the size of the aperture is reducing the incident energy—acting as a shield itself. As a rule of thumb, the SE due to the size of a rectangular aperture is approximately⁴

$$SE_{aperture} \approx 20 \log \frac{0.5\lambda}{d}, \quad (6)$$

Keith T. Jacoby, EEO; Matthew W. Pieratt, EEO; Jennifer I. Halman; Keith A. Ramsey, “Predicted and measured EMI shielding effectiveness of a metallic mesh coating on a sapphire window over a broad frequency range,” Window and Dome Technologies and Materials XI, Randal W. Tustison, Volume 7302, Page 7302OX, 2009

Copyright 2009 Society of Photo-Optical Instrumentation Engineers. One print or electronic copy may be made for personal use only. Systematic reproduction and distribution, duplication of any material in this paper for a fee or commercial purposes, or modification of the content of the paper are prohibited.

where λ is the wavelength and d is the largest dimension, and d is less than or equal to half of λ . However, this is the worst case scenario for aperture leakage, whereas our concern is with too much shielding of the aperture and our aperture orientation is with respect to the smaller dimension, 0.2 meters. As such, the aperture shielding begins to play a small effect when the frequency is just below about 750 MHz and plays an even greater effect as the frequency decreases. Figure 12 compares the aperture shielding to the window shielding and the shielding of a small aluminum plate. When the aluminum plate is substituted for the window, the results are nearly the same below 1 GHz. The shielding of aluminum at these frequencies is expected to be high, above 100 dB, so the aperture appears to have an effect on the results. When a comparison is made of the SE of the window with respect to the small aperture and the window with respect to the large aperture, an additional 5 to 20 dB of shielding was observed from about 30 MHz to 500 MHz, due to the larger aperture. A comparison was made between the large metal plate's shielding and the shielding of the window fixture with the gasket and no clear difference was seen. There appears to be a strong dependence of the SE results to the size of the aperture used for the incident energy. Though the data of incident energy getting through the aperture appears significant, a clear comparison of the enclosure's shielding to the aperture shielding has not been done. The exact affect of the aperture will need further investigation in future studies.

Below 750 MHz the aperture and the antenna separation are on the order of a wavelength. In general, the region within about a wavelength of the antenna is known as the reactive near-field. The region between one to several wavelengths is known as the radiating near-field. The far-field is the region greater than several wavelengths from the antenna or where the fields are nearly plane waves and the impedance of the wave in free space is equal to 377 ohms. As the frequency gets smaller and the wavelength gets longer, with the separation distance remaining constant, the fields become less real and more reactive, and consequently have greater stored energy. Reactive energy becomes far more difficult to characterize and the aperture exposure assumptions may just be a byproduct of phase manipulation. Limitations exist with reaching far-field conditions and exposing the proper size aperture, though methods to get around such limitations are being looked into. A clearer understanding of the aperture's effect on SE, as well as the choice of antenna and the configuration of the chamber needs to be obtained. Another area of interest is the measurement of both the electric and magnetic fields SE at low frequencies in what is called a dual transverse electromagnetic (TEM) cell.⁵

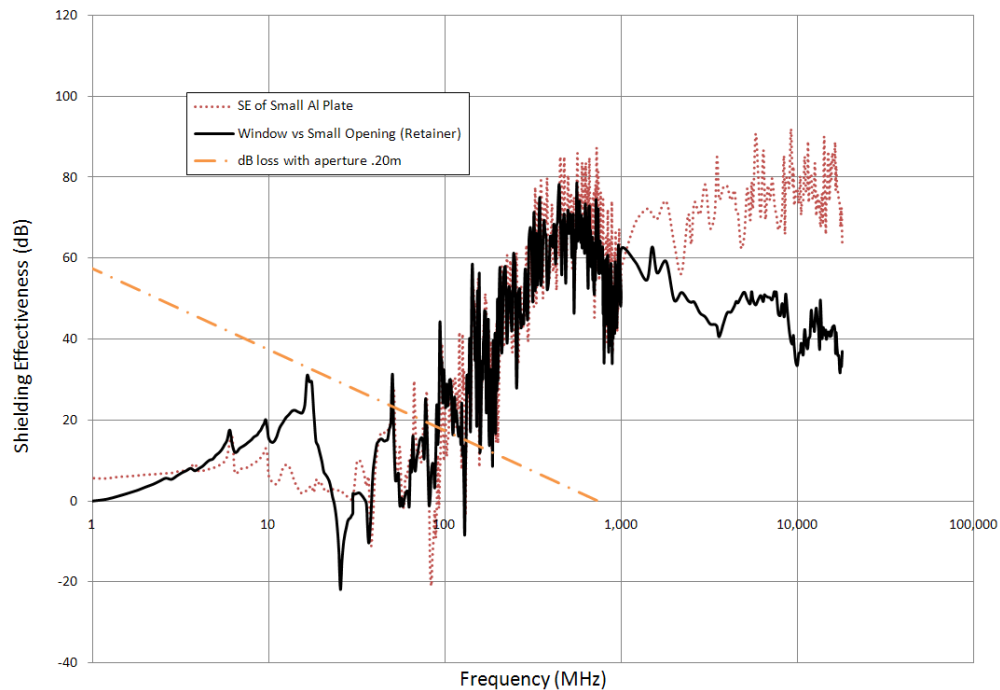

Figure 12: Shielding effectiveness measurement comparisons of the window and a small aluminum plate substituted for the window, 1 MHz to 100 GHz, log scale. The theoretical prediction of the aperture's shielding is also plotted, corresponding with the decline in the data.

Keith T. Jacoby, EEO; Matthew W. Pieratt, EEO; Jennifer I. Halman; Keith A. Ramsey, "Predicted and measured EMI shielding effectiveness of a metallic mesh coating on a sapphire window over a broad frequency range," Window and Dome Technologies and Materials XI, Randal W. Tustison, Volume 7302, Page 7302OX, 2009

Copyright 2009 Society of Photo-Optical Instrumentation Engineers. One print or electronic copy may be made for personal use only. Systematic reproduction and distribution, duplication of any material in this paper for a fee or commercial purposes, or modification of the content of the paper are prohibited.

7. CONCLUSION

The Battelle model is shown to reasonably predict the SE of the metal mesh coating and substrate for EM problems where plane-wave is a valid assumption. Battelle's model does provide an indication of the SE of the metal mesh coating and substrate for EM problems in a radiating near-field condition. The model results do not correlate to EM problems in the reactive near-field condition, which may be due to the nature of this region itself or a limitation of the aperture size.

The SE due to the aperture was predicted and its possible effect on the measurement was discussed. The effect of mounting, which includes the fixture and gasket, showed no clear contribution to the SE of the system. The ripple in the data was clearly seen both theoretically and experimentally in the GHz region, being a function of the dielectric constant, frequency, substrate thickness, and the orientation of the substrate. The contribution of the metallic mesh coating does provide 30-60 dB of shielding between 300 MHz and 18 GHz as predicted and measured, and is considered appropriate in this region. Below 300 MHz there is a clear divergence between predicted and measured SE performance. Due to the factors previously stated, the test results below 300 MHz could possibly be inaccurate thus preventing one from drawing a conclusion about the validity of the model and/or the viability of the SE of the mesh coating in this lower frequency region. The lessons learned from this effort will be used in further study of SE in the lower frequency region.

ACKNOWLEDGEMENT

This work was partially sponsored by the Air Force Research Laboratory (AFRL) under Contract No. FA 8650-06-D-5401/0012.

Fig. 4-9 used with permission from Stork-Garwood Laboratories, Pico Rivera, CA.

REFERENCES

- ¹ Klein, C. A., "Microwave Shielding Effectiveness of EC-Coated Dielectric Slabs", IEEE Trans. on Microwave Theory and Techniques, 38(3), 321-324 (1990).
- ² Klein.
- ³ Ruck, G.T., Barrick, D.E., Stuart, W.D., and Krichbaum, C.K. , [Radar Cross Section Handbook], Plenum Press, New York, 479-483 (1970).
- ⁴ Sharma, A. K., Mishra, K. K., Raghuramaiah, M., Naik, P. A., Gupta, P. D., "Design and performance characteristics of an electromagnetic interference shielded enclosure for high voltage Pockels cell switching system", Sadhana, 32(3), 235-242 (2007).
- ⁵ Wilson, P. F., Ma, M. T., "Shielding-Effectiveness Measurements with a Dual TEM Cell", IEEE Trans. On Electromagnetic Compatibility, 27(3), 137-142 (1985).

Keith T. Jacoby, EEO; Matthew W. Pieratt, EEO; Jennifer I. Halman; Keith A. Ramsey, "Predicted and measured EMI shielding effectiveness of a metallic mesh coating on a sapphire window over a broad frequency range," Window and Dome Technologies and Materials XI, Randal W. Tustison, Volume 7302, Page 7302OX, 2009

Copyright 2009 Society of Photo-Optical Instrumentation Engineers. One print or electronic copy may be made for personal use only. Systematic reproduction and distribution, duplication of any material in this paper for a fee or commercial purposes, or modification of the content of the paper are prohibited.

<http://dx.doi.org/10.1117/12.818200>